

LCN®

# Door controls

General information



# History of door controls and LCN

## Trinity Church

In 1876, Mr. L. C. Norton was sent to Boston, Massachusetts to help build the Boston Trinity Church. The church took over four years to complete. The church was located on the Back Bay facing south and west thus at times, encountering some very severe wind conditions. The church began operation in 1880, the pastor, Rev. Brooks and his congregation quickly found out that the strong winds would make the doors close with a thunderous bang. Needless to say, the pastor was not going to stand for all the noise; those doors needed to be controlled! This prompted Mr. Norton to action.

Mr. Norton's first attempt to remedy the situation was to hang the doors on double-spring hinges. Mr. Norton had now uncovered a second problem. The slamming stopped but now the strong winds made the doors stand open. The cold, drafting air raised protest amongst the people in the church. He tried rubber stops, special door linings, and some other ideas. Nothing worked. One day, continuing to ponder the problem with the doors at the Trinity Church, he put some things away in a closet and being in a hurry, he threw the door shut. To his amazement, the door did not slam. Instead, the door bounced back. He tried this over and over with the same result. An idea came to him; he rushed to town and purchased a beer pump. With the beer pump, a makeshift arm, and some special brackets he had designed, Mr. Norton installed his invention on one of the exterior church doors. He opened the door and let it go...crash! The door slammed so hard it broke the pump into many pieces.

Mr. Norton spent many months trying to solve the problem; finally, he used the principles of the lever, improved the main components, and decided to reposition the device on the door. He took his updated version and again installed it on one of the troublesome church doors. Rev. Brooks saw Mr. Norton's new design and to his delight, the closer worked perfectly. Mr. Norton had used air pressure to make the doors close quietly. The problems with the doors at the Boston Trinity Church were now solved.

## Growing pains

Soon after the doors at the Trinity Church were under control, Mr. Norton formed a company to manufacture his new found invention. The factory was located in Boston, Massachusetts and business started out strong. In fact, at times, there were more orders than production could match.

Time flew by. Mr. Norton's company began to experience difficulty. Competition was fierce. Some competitors began to infringe on patents, which drained Mr. Norton of both cash flow and other resources. Mr. Norton also made a few business decisions that would hamper company growth. The early years presented other challenges too. New closer designs were being introduced at an increasingly fast pace. This quick growth brought about some challenging quality issues. Business associates both good and bad, came and went. The factory moved to Brooklyn, New York and then back to Boston, Massachusetts. In these years, the door closer business was a volatile one. Most good companies were forced into change whether they liked it or not. The door closer industry was no exception.

## New beginnings

Competition drove Mr. Norton in a new direction. His air check had worked well but was slowly giving way to new technology. In 1900, Mr. Norton developed a liquid door check. This new liquid door check controlled the door through the entire door swing by incorporating three independent hydraulic regulations. Backcheck, general speed, and latch speed were necessary for total door control. In 1908, the company was moved to Chicago, Illinois. By the early 1920's, the door closer business was doing well but Mr. Norton was wearing down, he needed help.

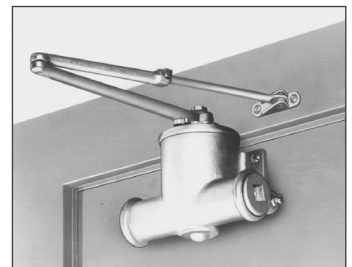

## Introduction

In 1925, Mr. L. C. Norton teamed with Mr. D. R. Lasier and formed the Norton-Lasier Company. The business was located at 466 West Superior Street in Chicago, Illinois Norton and Lasier knew that if their company was to survive, they must build a far superior product at a very fair price. They called their improved door closer an LCN. After



a few years, Mr. Norton left the business to Mr. Lasier and moved to California. During the years of 1926 through 1948, under the leadership of Mr. D. R. Lasier, LCN manufactured and shipped high-quality traditional style closers all over the world. Many of these closers are still in use today.

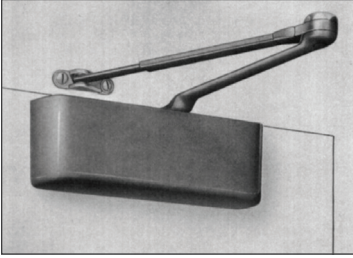

In 1949, the factory moved to Princeton, Illinois. In 1958, LCN introduced the heavy-duty 4010/4110 Series closer. Schlage Lock Company purchased LCN in 1959. In 1974, Ingersoll-Rand purchased Schlage Lock Company (and LCN). Today, LCN offers a complete line of door control products including heavy-duty hydraulic closers, automatic operators, fire/life safety closer/holders, high security closers and more.

The model numbers may have changed but the passion, quality, and excitement will always remain. LCN closers are made with premier materials and our products are tested far beyond the industry requirements.

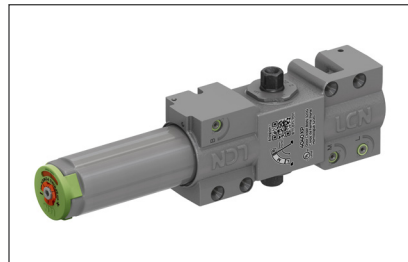

### Information and customer care



[us.allegion.com](http://us.allegion.com)



US 877-671-7011  
Canada 800-900-4734



**Customer service**  
[Support@allegion.com](mailto:Support@allegion.com)

**Product support**  
[Closers\\_TechProdSupport@allegion.com](mailto:Closers_TechProdSupport@allegion.com)



[www.youtube.com/LCNHardware](http://www.youtube.com/LCNHardware)

### Ordering



[Allegion\\_Orders@allegion.com](mailto:Allegion_Orders@allegion.com)



eFax: 1.800.248.1460

- 1851** Lewis C. Norton born May 5th in New Hampshire.
- 1880** First door closer installed at Boston Trinity Church.
- 1881** Manufacturing begins at Boston plant.
- 1900** Mr. Norton introduces a liquid door check.
- 1908** Company moves to Chicago.
- 1917** David R. Lasier joins company as timekeeper.
- 1925** Norton-Lasier Company begins operation.
- 1929** L. C. Norton moves to California. D. R. Lasier heads up company.
- 1930** Norton-Lasier Company produces wooden riding toys to cope with the Great Depression.
- 1937** L. C. Norton passes away on November 4th.
- 1942** Norton-Lasier Company produces hydraulic aircraft fittings for the war effort.
- 1948** Norton-Lasier Company officially changes name to LCN.
- 1958** LCN introduces the 4010/4110 Series door closer.
- 1959** LCN sold to Schlage Lock Company.
- 1972** LCN introduces Sentronic line of fire/life safety holder/closers.
- 1973** LCN introduces the 4040 series door closer.
- 1974** Schlage Lock (and LCN) sold to Ingersoll-Rand.
- 1978** LCN introduces Equalizer units.
- 1980** Production on traditional series ends.
- 1981** LCN introduces the 1460 Series door closer.
- 1981** LCN introduces AutoEqualizer™ units.
- 1985** LCN introduces the 1070 Series door closer.
- 1993** LCN introduces the powder coat finish.
- 1995** LCN introduces Electric Operator units.
- 1996** LCN introduces the 1520 Series door closer.
- 1998** LCN introduces the 1370 Series door closer.
- 2006** LCN introduces the new 4030 Series door closer to replace the 1520 closer series.
- 2006** LCN introduces the new Senior, Astro and Middle Swing Digital Control Box.
- 2007** LCN introduces the new Tri-Volt Magnets.
- 2007** LCN introduces the new 4040XP.
- 2007** LCN introduces the new 1260 Series.
- 2013** In December of 2013, the Security Technologies division of Ingersoll Rand became its own publicly traded company called Allegion.
- 2015** LCN introduces the 1250, 1450 and 4050A Series cast aluminum door closers.
- 2021** LCN introduces the 6400 Compact™ series low-energy automatic operator, supporting ADA compliance and touchless access.
- 2022** LCN enhances the 4040XP door closer to make it easier to install and maintain.

# The LCN formula for success

Since its founding in 1926, LCN has specialized in solving door control problems through the use of high quality, innovative door control products. By adhering to high standards of performance, LCN has earned a leadership role within the industry and is committed to meeting door control challenges of the future. With representatives located throughout the world, LCN provides the products and services necessary to solve your door control problems.



**Materials**  
Material control is foundational to the consistent performance of LCN closers. Consequently, we hold our material suppliers to rigorous standards for the cut and type of raw materials they provide. Suppliers are required to show certification that the raw materials adhere to LCN standards.



**Extensive abuse test**  
LCN door closers go through robust testing, beyond industry requirements, to ensure you get performance you can trust in real-world applications. In addition to meeting ANSI and BHMA industry compliance standards, our engineers seek to understand just how much our closers can handle.

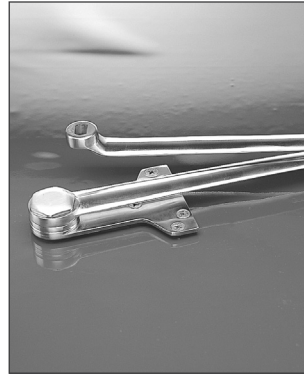

**Forged steel arms**  
The closing power and control generated within LCN closers is transferred to the door through forged steel arms. Forged steel arms have greater strength, better appearance and less bulk.



**Green Dial**  
LCN's Green Dial is a user-friendly tool that makes adjusting a door closer fast, easy and foolproof. Installers can easily tune in the performance of a closer.



**Heat-treated**  
The process of double heat treating pinions gives proper hardness and strength to the parts where they need it and maximizes torque rating, reduces wear and, ultimately, readies it to withstand abusive applications.

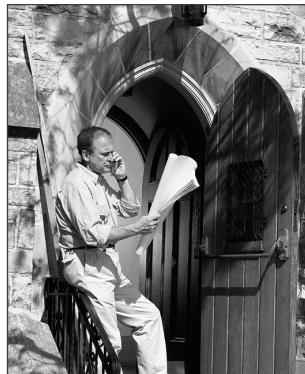

**Special templates**  
LCN offers a variety of custom door closers solutions. With over 3,000 special templates on file, LCN can provide a door control solution for one-of-a-kind doors such as vault, balanced, over-sized and arch doors.



**Hydraulic fluid**  
LCN's Liquid X is one of the primary reasons our closers can operate at extreme temperatures. This unique all-weather hydraulic fluid helps maintain consistent closer performance throughout seasonal changes.



**Customer service**  
We have a phone support team able to address countless product questions. Whether we're consulting on code, advising a door specification or answering installation questions, we are focused on making your interaction with LCN a positive one.

## Door controls aim to execute the perfect opening and closing cycle

In most applications, a pedestrian manually opens a door and a door closer controls the speed and force with which the door shuts behind them. The power to close the door is generated by the springs inside the closer. Regulated hydraulic circuits control the speed of the door's closing swing. An ideal door closing cycle can be achieved using one of the many LCN door closers available.

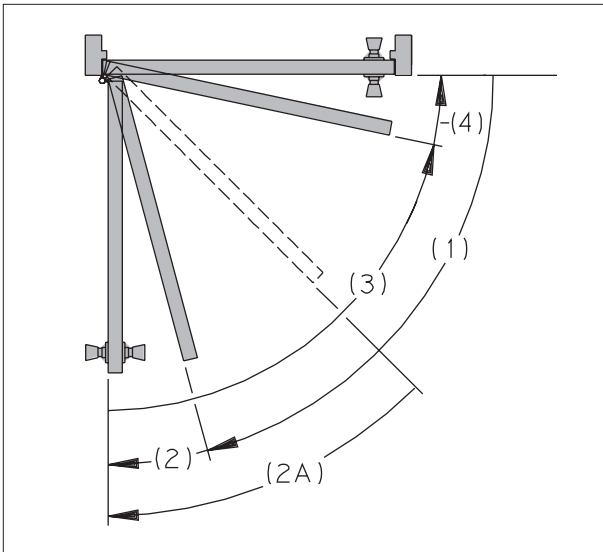

### Diagram shows the main stages in correct door operation

1. On the opening swing, the door closer's function is to let the door open easily, except at the end of the swing where backcheck is applied.
2. Backcheck is a feature that cushions the opening swing to prevent the door from slamming into the stop. Special closers designed for potentially abusive applications begin the backcheck function much earlier (2A) such as LCN's Advanced Variable Backcheck (CYLAVB).
3. Through the long closing arc, a uniform, reasonable (main) speed should be maintained.
4. The latching arc brings the door to a quiet, secure close.

### Opening the door builds up the power that later closes the door

As a controlled door is opened, the spring of the closer is compressed which builds up the power to close the door. Normally, more opening force would be required as spring compression increases. However, an LCN closer changes its arm geometry while the door opens, which increases the door leverage. This offsets the spring compression, resulting in greater ease in opening the door.

### In opening, more leverage for the person

The changing arm geometry increases leverage over the door to overcome the growing power of the spring and allows one to pass through the door easily.

### In closing, more leverage for the closer

When the person releases the door and the closer takes over, spring power is applied through the arm system to close the door. Because the spring has been compressed, its power is very high. As the door closes the spring expands, providing the power to close the door.

### Special closers for reduced opening force

The 1990 Americans with Disabilities Act (ADA) and ANSI Standard A117.1 describe maximum opening force limitations for certain non-fire rated doors. The last page of each closer section in the catalog includes a section titled Reduced Opening Force Closers. This section lists closers in that specific series that will comply with a maximum opening force based on the width of the door.

Any manual door closer, including those certified by BHMA to conform to ANSI Standard A156.4, that is selected, installed, and adjusted based on ADA or other reduced opening force requirements may not provide sufficient power to reliably close and latch the door.

Refer to LCN Automatic Operators catalog for information on electric, pneumatic and electromechanical systems that meet reduced opening force requirements without affecting closer power.



## How to select a door closer

### Concealed or surface mounted closers

Door closers are available in two styles - concealed or surface mounted. When choosing a closer style for a particular application, consideration should be given to the type of door being controlled, frame conditions, aesthetic requirements, and control features needed. The following information can serve as a guide in selecting the style and model of closer to meet specific requirements.

#### Concealed application

Closers concealed in the head frame over the door are out of sight and out of the pedestrians way. They are more protected from external contaminants than those mounted outside of the door. They are easy to reach for regulation without removing any parts. Closers for frame sections as thin as 1 3/4" (44 mm) are available.

Closers located within the door itself are also hidden and protected but recommended for interior doors only.

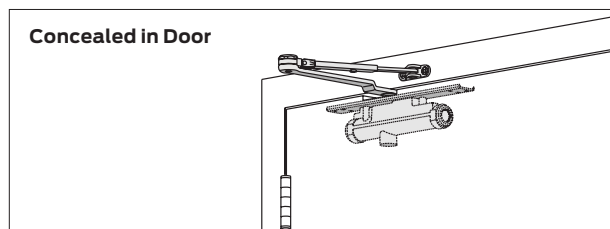
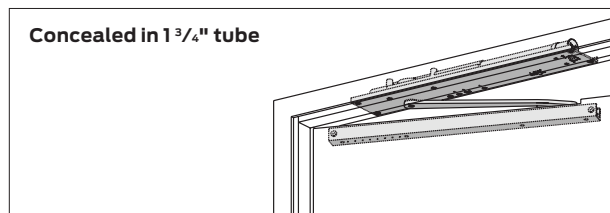
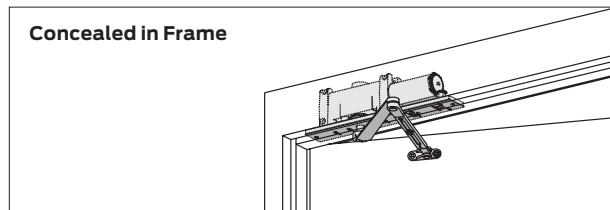

### Surface mounted application

Closer location is subject to the considerations of practicality and appearance. Standard application usually decrees that closers on doors along a corridor be located on the room side of the door so they are out of the line of sight from the corridor. Closers should be placed on the inside of exterior doors for optimal aesthetics and to shelter them from environmental elements.

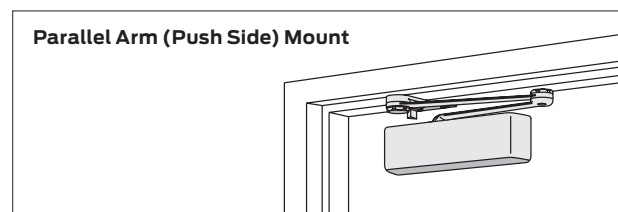
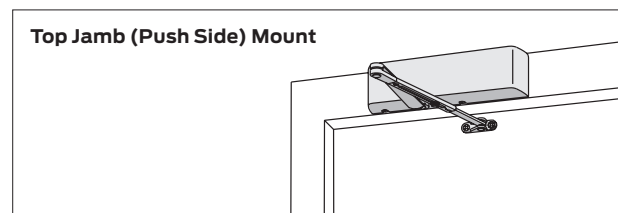
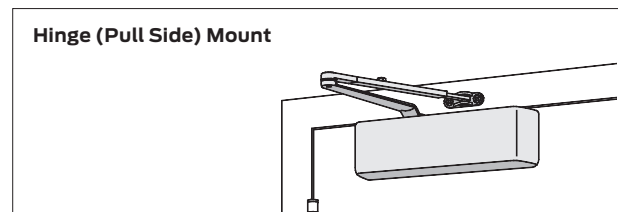

### Where heavy duty closers are required

Heavy duty closers are the recommended solutions in the following locations:

1. Schools or public buildings where heavy or abusive usage is expected.
2. Exterior doors.
3. Doors subject to draft, winds, or air pressure differentials.
4. High frequency doors such as those on department stores, malls, or mixed use tenancies.

## Mechanical considerations

# How to select a door closer

## Arm system options

### Double lever arm

Double lever arm closers can provide control under difficult conditions for either interior or exterior doors. A parallel arm system is a type of double lever arm where the main arm is parallel to the face of the closed door. Available double lever arms:

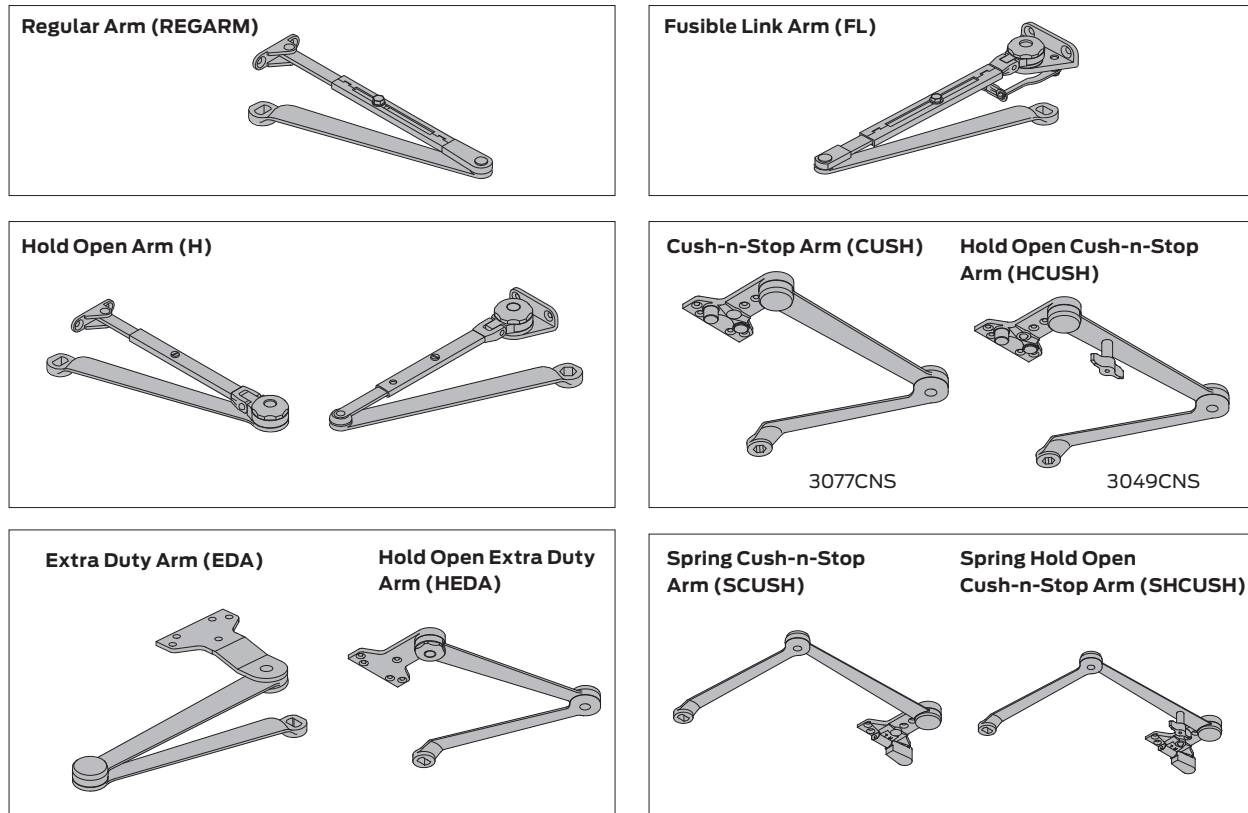

### Single lever arm

Single lever arm (track) closers may be used on interior or sheltered exterior doors. The hold open function in a single lever arm system is provided by either the track or the cylinder assembly. Available single lever arms:

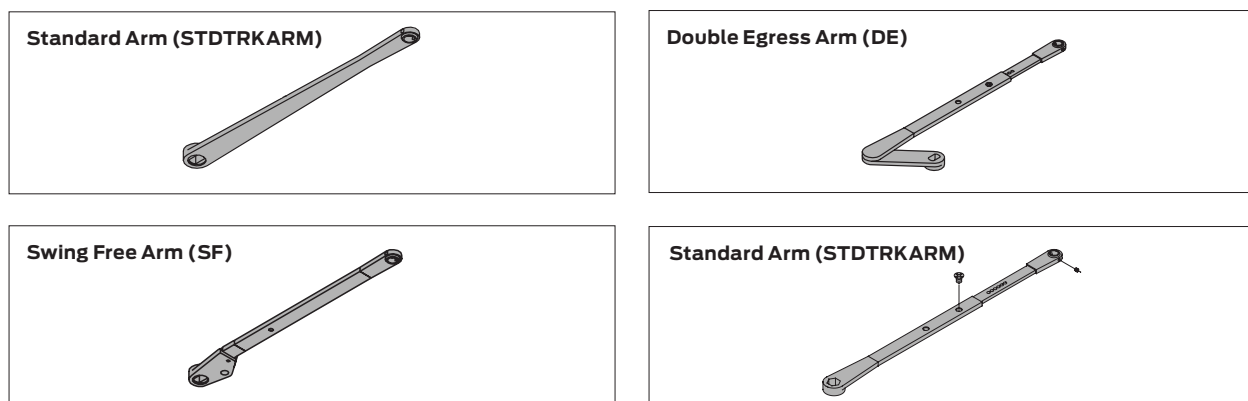

## How to select a door closer

### Special cylinder functions

#### Delay Action (CYLDEL)

Many LCN closers can be ordered with a delayed action function built into the cylinder. Delay Action (CYLDEL) is a special hydraulic circuit that provides additional time to pass through the door. A special regulating screw controls the closing speed from maximum opening through approximately 75°. After that point the normal main speed resumes control to close the door. Delayed action is not available with single lever arm (track) closers.

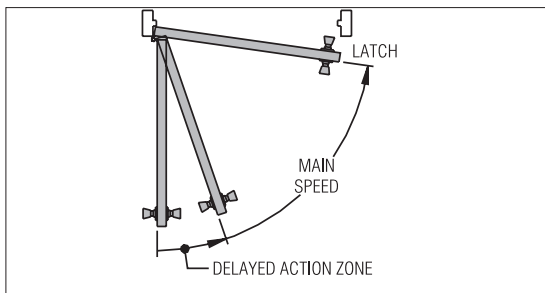

#### Advanced Variable Backcheck (CYLAVB)

CYLAVB is available with high security and 4110 Series closers to begin cushioning the opening swing at about 45° (2A) instead of the usual 75° (2). CYLAVB is recommended for potentially abusive applications.

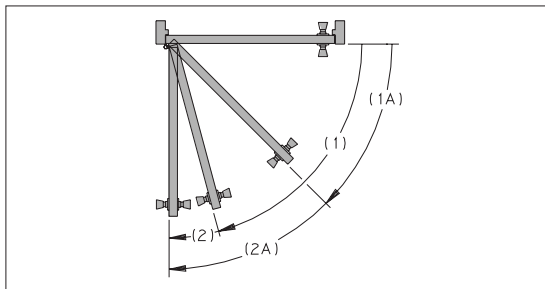

#### Multi-point (ME Series)

ME Series closer/holders can be ordered with a hold open bypass at either 80° or 140° function. This feature does not allow hold open to take effect until opened beyond the selected degree of bypass.

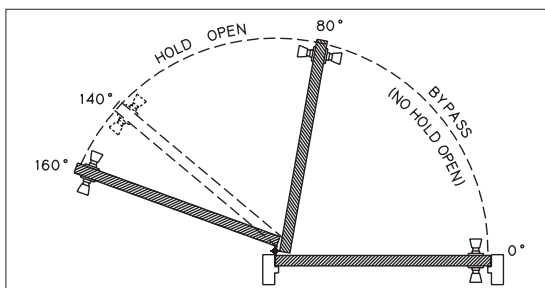

### Seasonal adjustment

Temperature changes can affect the operation of common door closers by changing the viscosity of the hydraulic fluid inside the closer. As temperature rises, the fluid thins out and closes the door more rapidly. As temperatures decrease, the fluid thickens causing the closer to close the door very slowly.

LCN's Liquid X reduces the amount of adjustments and maintenance needed through every season.

### Hanging the doors

While butt hinges provide the most common method of hanging doors, some doors are hung on pivots centered in the door, others on offset pivots. Surface mounted closers will handle doors hung in any of these three ways. LCN 4020 Series closers can even control a "balanced" door installation. Concealed closers may conflict in location with pivot leaves and thus may require special templating.

### Degree of opening

Three basic rules apply to maximum degree of opening.

1. It is best to let the door swing as far as it can swing freely. Closers are mounted in different locations for different degrees of opening.
2. Use a mechanical stop when a door can not swing 180° or at the selected hold open point of a double lever arm system. The mechanical stop can be mounted on the floor, wall, overhead, or built into the closer arm.
3. The closer should be positioned so backcheck takes place well in advance of the stop position to cushion the opening swing and prevent door and frame damage from an abrupt stop.



## Mechanical considerations

### How to select a door closer

#### Door dimensions

The width of the door is the main consideration in determining the correct closer size. Size here refers to the minimum spring power and hence the closing force, generated by the closer. In the catalog, the interior and exterior table of sizes for each closer are set up for ranges of door width and assume normal operating conditions. If a door is of exceptional height, weight, special construction, or if drafts and air pressure differentials exist, increased closer power should be considered.

Door thickness may be a factor. A concealed-in-the-door closer should not be used in a hollow metal door less than 1 1/2" (38mm) thick or a wood door under 1 3/4" (44mm). Exceptionally thick doors can affect hinge and pivot centers to the extent that closer functions and geometry are also affected.

The depth of the door's top rail is important to nearly every closer installation. Narrow top rails may require plates to successfully mount the closer. An insufficient top rail in flush, hollow, or composite filled doors may make concealed-in-the-door installations impractical.

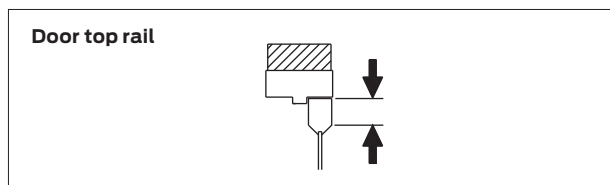

#### Handed closers

Some door closers are handed. When approaching a door from the push side, if hinged on the left, it is a left hand door; if hinged on the right, it is a right hand door.

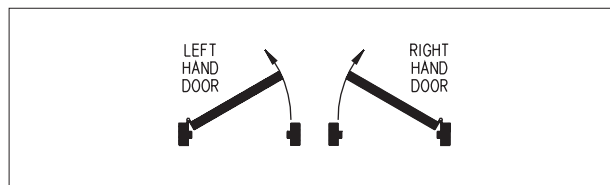

For purposes of handing door closers, right hand reverse bevel and left hand are identical. Also, left hand reverse bevel and right hand are identical.

#### A standard closer and template to meet your needs

Occasionally the physical limitations of the selected closer may not provide the desired functions or degree of opening. Standard templated locations may interfere with other applied hardware. In these

situations, contact the LCN Applications Engineering Department for assistance. Customized installation templates or products may be available to solve a non-standard application.

#### Plates, brackets, adapters and other special pieces

A drop plate is now commonly used to drop (lower) closers to meet special conditions or adapt a closer to door or frame surfaces that are not adequate for normal mounting patterns.

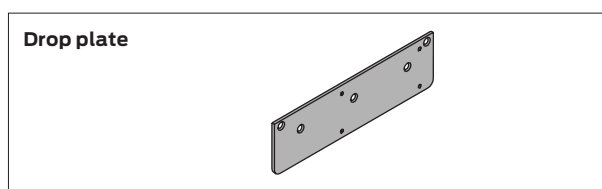

Specialized brackets, adapters, and parallel arm shoes are available to simplify the installation of closers with a variety of frame and door conditions. The most commonly used are listed with each closer. Consult LCN for assistance if you are not sure.

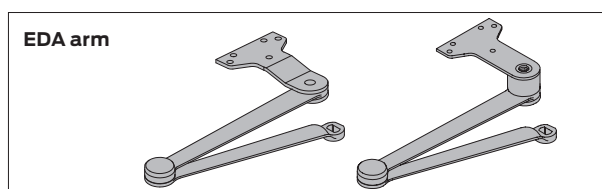
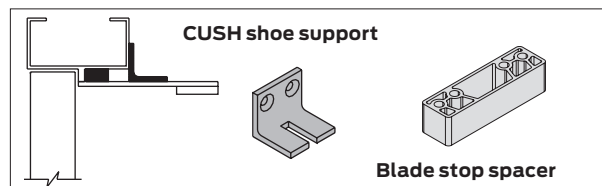

#### Fastener options

LCN closers are shipped with Wood and Machine Screws (WMS) or Self Reaming and Tapping Screws (SRT) unless other fasteners are ordered. These screw packs are suitable for wood or properly reinforced hollow metal frames and metal or solid core wood doors. For wood door applications, LCN recommends the use of wood screws. For selected closers, metric machine screws are available in lieu of UNC/UNF machine screws.

## How to select a door closer

When attaching closers to hollow core doors, optional Through Bolts (TB) are recommended to minimize crushing or squeezing the door. Through bolting can also provide a very strong mechanical connection for potentially abusive applications. Because the TB barrel extends completely through the door, the door thickness must be specified when ordering if it is other than 1 3/4" (44 mm). TBs are only available for 1/4"-20 machine screws.

For high security applications, Torx machine screws are available with most closers. These are standard for all exposed fasteners with high security closers. Torx fasteners feature a hex lobular drive with a security pin in the center. They can only be installed or removed with a special set of bits that are available from LCN.

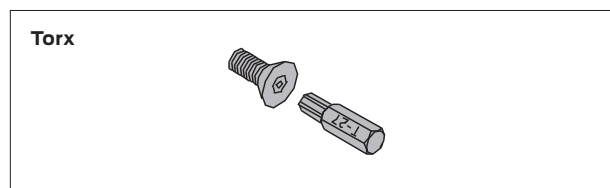

### Desired finishes

LCN powder coating provides superior protection against the effects of weather conditions and is an environmentally friendly process. The high quality, chip resistant finish is far superior to any previously offered. Corrosion resistance surpasses 100 hours salt spray testing (four times the industry standard). Non-metallic components also provide the same high resistance to the effects of the elements. All LCN products are shipped with a finish.

LCN offers custom finishing services to complement special installations. This provides a custom appearance and all the corrosion resistance inherent in the standard powder coated finishes. It is recommended that the customer submit a physical sample of desired custom finish with the closer order. Custom powder coat finishes are available at additional cost. A metal cover must be ordered when custom powder coat finishes are desired.

With some exceptions, visible components such as covers, arms, fasteners, and finish plates are available in plated finishes. Tracks are painted to complement the plated finish. Hidden assemblies such as cylinders and mounting plates are supplied with a powder coated finish. Plated finishes are available at additional cost.

For installations where a higher level of protection against

weathering is required, LCN offers a Special Rust Inhibitor (SRI) process at an additional cost. Metal components receive an SRI pretreatment and a standard or custom powder coat finish. The SRI process with a powder coat finish exceeds the protection level available with powder coated parts. SRI can not be ordered with plated or anodized finishes. All closers must be shipped with a finish.

### Installation process

Before installation of the door closer:

- Review the installation instructions provided with the door closer.
- Verify the desired installation and template with the hardware schedule. Review other applied door hardware for possible interference.
- Verify that the frame attachments and door hinges or pivots are securely installed.
- Verify that the door is hung properly and operates smoothly through it's entire range of opening. Misalignment, sagging or other conditions that prevent free movement of the door must be corrected prior to installation of the door closer. LCN recommends < 1/4 lbf to open the door before installing closers for ADA applications.
- Check latching mechanisms for proper operation and release.
- Verify that the door and frame have specified reinforcements.
- Verify that all required tools are available.

To complete the installation:

- Follow the installation instructions and use fasteners provided with the closer.
- Use the template provided with the closer, layout, drill and tap (for metal screws) the required mounting holes. Be sure to use the proper size drill bit and tap to ensure maximum holding power by the screws.
- For closers with adjustable spring power, adjust the cylinder spring power based on the width of the door as described in the installation instructions.
- The hydraulic backcheck main speed and latch speed regulation adjustments of the door closer have been adjusted at the factory to meet normal installation conditions. If further adjustments are required to the hydraulic regulation, follow the directions included with the installation instructions.
- Lightly wipe the cover and arm surfaces with a soft, clean, dry cloth to remove any dirt or smudges that occurred during the installation.

## Finishes

### Standard powder coat finishes

LCN powder coating provides superior protection against the effects of weather conditions and is an environmentally friendly process. The high quality finish is chip resistant. Corrosion resistance surpasses 100 hours salt spray testing (four times the industry standard). Non-metallic components also provide the same high resistance to the effects of the elements. All LCN products must be shipped with a finish.

#### LCN standard finishes (ANSI/BHMA number):

622 Matte Black



690 Statuary Bronze



693 Gloss Black



696 Brass



689 Aluminum



691 Light Bronze



695 Dark Bronze



### Optional custom powder coat finishes

LCN offers custom powder coating to provide a custom appearance and all the corrosion resistance of standard powder coat finishes at a nominal additional cost. LCN uses the RAL numbering system for the 150+ custom colors available. Contact your local RSO representative for a brochure showing the available custom colors.

Note: Custom powder coat finishes require a metal cover.

### Optional plated finishes

Visible components such as metal covers, arms, fasteners, and finish plates are plated to match the selected finish. Surface mounted tracks are powder coated to compliment the plated finish. Hidden assemblies such as cylinders, tracks, and mounting plates are supplied with a powder coated finish. Plated finishes require handing of closers.

#### Plated finishes:

616 Satin Bronze, Blackened	646 Satin Nickel
632 Bright Brass	651 Bright Chrome
633 Satin Brass	652 Satin Chrome
639 Satin Bronze	

### Special Rust Inhibitor (SRI) process

For installations where a higher level of protection against weather conditions, or the effects of a potentially corrosive atmosphere is required, LCN offers a Special Rust Inhibitor (SRI) process. Ferrous metal components receive an SRI pretreatment and a standard powder coat finish of your choice, or a custom powder coat finish for a nominal additional cost. Closers treated with the SRI process exceed the 100 hour protection level available with standard LCN powder coated finishes. For details, contact your local RSO representative or the LCN factory.

### Standard anodized finishes

LCN Senior Swing and Benchmark electromechanical automatic operators are offered with an anodized finish. Anodizing is an electrochemical process that thickens and toughens the protective oxide on aluminum metal.

#### LCN anodized finishes:

628 Aluminum, Clear Anodized  
710 Dark Brown, Anodized

## Materials

The LCN offering consists of well-made, reliable, long-lasting products that work in real-life applications. In addition to the mechanical advantages derived from proven designs, much of the durability of the closer and arm system is directly related to the materials used in their manufacturing.

Precision machined cast iron cylinders and forged steel pistons work together because of the compatibility of their basic elements. Heat-treated pinions and pistons spread the load over a large gear tooth system to better handle the wear and stress of millions of operating cycles. Upper and lower full complement pinion bearings provide the support and load capacity required by the design of the closer. All-weather fluid, Liquid X, reduces the amount of adjustments and maintenance needed and ensures consistent performance through every season.

Forged steel main arms are a durable alternative to lower-cost stamped steel arms. Specially designed shoe and elbow joints help each closer fit securely onto a variety of opening applications. A state-of-the-art, powder coat process delivers a high quality, corrosion resistant finish on all metal parts in popular architectural finishes.

Through state-of-the-art equipment, processes and people, we believe LCN will continue to provide the best solutions for our customers.

## Part 1 - General

### 1.1 Quality assurance

#### A. Reference standards

- American National Standards Institute (ANSI/BHMA):
  - A117.1 Providing Accessibility and Usability for Physically Handicapped People
  - A156.10 For Power Operated Pedestrian Doors
  - A156.4 Door Controls - Closers
  - A156.15 Life Safety Closer Holder Release Devices
  - A156.18 Materials and Finishes
  - A156.19 Power Assist and Low Energy Power Operated Doors
- Americans with Disabilities Act (ADA)
- American Society for Testing and Material (ASTM): Specification B117-9 Method of Finish Corrosion Testing
- Underwriters Laboratory (UL):
  - 228 Door Closers-Holders
  - UL10C Standard Positive Pressure Fire Test of Door Assemblies
  - UL10B Standard for Fire Test of Door Assemblies
- National Fire Protection Association (NFPA)
  - No. 80 Fire Doors and Windows
  - No. 101 Life Safety Code

#### B. Source quality control

- Obtain each kind of hardware (latch and lock sets, hinges, closers, etc.) from only one manufacturer, although several may be indicated as offering products complying with requirements.
- All products shall meet grade 1 or the highest level of cycle test requirements of the applicable ANSI/BHMA standard.

#### C. Supplier qualifications

- Supplier must be a recognized builders hardware supplier who has been furnishing hardware in the projects vicinity for a period of not less than two years.
- Supplier must be or employ an experienced hardware consultant who is available, at reasonable times during the course of the work, for consultation about the project's hardware requirements, to Owner, Architect, and Contractor.

#### D. Fire-rated openings

- Provide hardware for fire rated openings in compliance with NFPA Standard No. 80, NFPA Standard No. 101, and local building codes.
- [Manual Hold Open Arm function not allowed.]** Provide hardware which has been tested and listed by UL for types and sizes of doors required and complies with the requirements of door and frame labels.

- one piece forged steel pistons.
- Fluid of a type requiring no seasonal adjustments.
- [Excluding 1460, 1260, 3030, 3130 4030, 4040XP, 1250, 1450, and 4050A Series.]** Pinion shaft minimum diameter of  $\frac{1}{16}$ ".
- Hydraulic regulation controlled by tamper-proof, non-critical screw valves, adjustable with a hex wrench.
- Separate adjustments for backcheck, general speed, and latch speed.

**[Applies to 1450, 1460, 4010, 4020, 4040XP, 4050A, 4110, 4210, 4510, 5010 Series.]** Where detailed on double lever arm closers, provide a delay action feature to delay closing up to one minute from maximum opening to approximately 75°.

- backcheck shall be properly located for protection of the door, frame, and applied hardware.

**[Applies to 2210, 4110, 4210, 4210T, 4510, and 4510T Series only.]** Where detailed, provide advanced variable backcheck to start backcheck function at approximately 45°.

- Include high efficiency, low friction full complement pinion bearings.
- [Excluding 1260, 1460, 6030 Series.]** Forged steel main arms.
- [Applies to 4110, 4210, 4510 Series and all EDA and CUSH arms.]** Forged steel main and forearm.
- [Applies to all single lever arm (track type) closers.]** Where detailed, provide a quiet, low friction track and roller assembly and provisions for an optional bumper assembly to assist backcheck and/or Hold Open Clip.
- [Applies to all double lever arm closers, except EDA or CUSH arms.]** Reversible shoe to increase latching power of the closer.

#### B. Size of closers

- Sized in accordance with ANSI/BHMA Standard A156.4 as shown in the applicable table of sizes listed in the current LCN catalogs.
- Closing power of non-sized cylinders shall be adjustable over a range of sizes; **[Applies to 1250, 1261, 1450, 1461, 1460T, 4011, 4021, 4040SE, 4040XP, 4040XPT, 4041DEL, 4050A, 4111, 4211, 4511, 4631, 4642, 4811, 4822, 4841, 4031, 4031T Cylinders.]**

#### C. Barrier free manual closers

- All closers for openings that must meet the minimum requirements of the ADA act, in lieu of ANSI/BHMA Standard A156.4, shall be sized in accordance with the applicable REDUCED OPENING FORCE table in the current LCN catalogs.
- All size 1 manual closers shall provide or be adjustable to provide less than 5 pounds opening force on a 36" door leaf and delay closing time in accordance with the ADA requirements.

#### D. Combination door closers and holders

- Provide closer/holders designed to hold the door in the open position under normal usage and to release and automatically close the door under fire conditions. Closer will include an integral electromagnetic holder mechanism designed for use with UL listed fire detectors, provided with normally closed switching contacts.
- [Applies to all ME models.]** Where detailed, multi-point closer/holders shall incorporate a hold open bypass feature from 0° up to either 80° or 140°.
- [Applies to 4310 ME only.]** Where detailed, multi-point closer/holders shall provide a swing-free function with a no-drift feature.

#### E. High security closers

- Provide closers designed to resist vandalism and tampering.
- All exposed fasteners shall be Torx machine screws with a security pin.

## Part 2 - Products

### 2.3 Materials and fabrication

#### A. General

- Closers shall be installed to allow door swing as shown on plans. Doors swinging into exit corridors should provide for corridor clear width as required by codes.

### 2.8 Closers and door control devices

#### A. General

- All closers shall have the following features:
- All closers shall carry manufacturer's warranty, as stated on page 27.
  - All closers with electrical or pneumatic components shall carry a manufacturers two (2) year warranty. **[Items 3 through 11 apply to closer cylinder, items 12 through 15 apply to closer arms.]**
  - [Excluding 1250, 1450, and 4050A]** Fully hydraulic, rack and pinion action with high strength cast iron cylinders and

## Part 2 - Products (cont.)

3. All closer adjustments shall be shielded by the cover or finish plate, after installation.
4. Arm and, where furnished, high security roller assembly shall be designed to prevent disassembly.
5. **[4210T and 4510 Series only.]** All surface mounted high security closers shall include a cast iron cylinder, heavy gauge metal covers with four mounting screws and double lever arms manufactured to prevent disassembly.
6. **[4210T and 4510T Series only.]** All surface mounted high security closers shall include a cast iron cylinder, heavy gauge metal covers with four mounting screws, heavy duty arm with special security roller, and a heavy gauge high security track designed to eject foreign objects.
7. **[2210 and 2210 DPS only.]** All concealed high security closers shall include a cast iron cylinder,  $\frac{3}{8}$ " steel mounting plate, heavy duty arm with special security roller, and a heavy gauge high security track designed to eject foreign objects.
8. **[2210 DPS only.]** A built-in door position switch shall be optional with concealed closers.

**F. Automatic operators**

1. Where low kinetic energy, as defined by ANSI/BHMA Standard 156.19, automatic operators are indicated for doors required to be accessible to the disabled. Provide pneumatic, electrohydraulic or electromechanical **[2810, 2850, 2860, 4630, 4640, 9130, 9140, 9150, 9530, 9540, 9550, 9560 Series]** operators complying with the ADA for opening force and time to close standards.
2. Full closing force shall be provided when the power or assist cycle ends **[2610, 2810, 2850, 2860, 4630, 4640, 4810, 4820, 4840, 9130, 9140, 9150, 9530, 9540, 9550, 9560 Series]**.
3. **[2610, 4810, 4820, 4840]** Locate power unit and pneumatic exhaust away from door to minimize noise and vibration in pedestrian areas.
4. All automatic operator systems shall include the following features and functions.
  - a) Provisions for separate conduits to carry high and low voltage wiring in compliance with the National Electrical Code, section 725-31.
  - b) The operator will be designed to prevent damage to the mechanism if the system is actuated while the door is latched or if the door is forced closed during the opening cycle.
  - c) All covers, mounting plates and arm systems shall be powder coated and successfully pass a minimum of 100 hours testing as outlined in ANSI/BHMA Standard A156.18 **[2610, 4630, 4640, 4810, 4820, 4840 Series]**.  
-Or-  
d) Electromechanical automatic operators shall be standard anodized either in aluminum or dark bronze. Custom anodized finishes and custom paint are available and can be specified. **[2810, 2850, 2860, 9130, 9140, 9150, 9530, 9540, 9550, 9560 Series]**
  - e) UL listed for use on labeled doors
  - f) **[4630, 4640, 4810, 4820, 4840 Series]** shall be non-handed with spring power over a range of at least four sizes either 1 through 4 or 2 through 5.  
-Or-  
g) **[2810, 2850, 2860, 9130, 9140, 9150, 9530, 9540, 9550, 9560, Series]** are handed and feature a spring return.
  - h) Provisions in the control box or module shall provide control {inputs and outputs} for; electric strike delay, auxiliary contact, sequential operations, fire alarm systems, actuators, swing side sensors, stop side sensors. **[2610, 4630, 4640, 4810, 4820, 4840, 9130, 9140, 9150 Series]**
5. **[4630, 4640 Series]** All electrohydraulic automatic operators shall include the following features or functions:
  - a) Second Chance Feature: When an obstruction or resistance to the opening swing is encountered the

operator will pause at that point, then attempt to continue opening the door. If the obstruction or resistance remains, the operator will again pause the door.

- b) Easily accessible main power and maintain hold open switches will be provided on the operator.
  - c) An electrically controlled clutch to provide adjustable opening force.
  - d) A microprocessor to control all motor and clutch functions.
  - e) An on-board power supply capable of delivering both 12V and 24V outputs up to a maximum of 1.0 ampere combined load.
  - f) All input and output power wiring shall be protected by a resettable circuit breaker.  
-Or-
5. All electromechanical automatic operators shall include the following features of functions:
    - a) Maximum 8 1/2 lbs of manual opening force **[9130, 9140, 9150 Series]**.
    - b) Maximum 15 lbs of manual opening force **[2810, 2850, 2860, 9530, 9540, 9550, 9560 Series]**.
    - c) Bottom loaded header for easy access to controls **[2810, 2850, 2860, 9550, 9560 Series]**.
    - d) Power Boost, which adds an additional 25 lbs of closing force at latch **[2810, 2850, 2860, 9130, 9140, 9150, 9530, 9540, 9550, 9560 Series]**.
    - e) Self contained automatic operators in a cast aluminum housing and a forged steel arm **[2810, 2850, 2860, 9130, 9140, 9150, 9530, 9540, 9550, 9560 Series]**.

**2.12 Hardware finishes****A. Finish**

1. All closers with powder coat finishes shall exceed a minimum 100 hour salt spray test, as described in ANSI/BHMA Standard A156.4 and ASTM B117.
2. All closers detailed with plated finishes shall include plated covers (or finish plates), arms, and visible fasteners.
3. All electromechanical automatic operators supplied with anodized finishes.
4. All closers must be shipped with a finish.

## Part 3 - Execution

**3.1 Installation****A. General**

1. Installation shall be in accordance with the templates and installation instructions packaged with the closers at the time of manufacture.
2. Installation shall be made with fasteners packaged with the closer by the manufacturer.
3. All electrical connections shall be made in accordance with the manufacturers recommendations.
4. Clean installed closer to remove dirt, debris, and marks incidental to installation work.
5. Installation instructions and templates are to be turned over to the Owners representative upon completion of the installation work.
6. Factory trained representative will be available for job site inspection of major projects upon completion of the hardware installation work.

**3.2 Adjustment****A. Adjustment**

1. Install and regulate all closers in accordance with the installation instructions packaged with the closers at the time of manufacture.
2. If unfamiliar with LCN products furnished, consult factory representative prior to installation for assistance.

# ANSI/LCN product cross reference

## Surface mounted

## ANSI Standard A156.4-2013

ANSI number	Mounting	LCN closer	PT-4A	PT-4B	PT-4C	PT-4D	PT-4F	PT-4G	PT-4H	PT-4J	
C02011	Hinge Side	4031	■	■	■	■				■	
		4040XP	■	■	■	■				■	
		1250	■	■	■	■				■	
		1260	■	■	■	■		■		■	
		1450	■	■	■	■				■	
		1460	■	■	■	■		■		■	
		4010	■	■	■	■		■		■	
		4050A	■	■	■	■				■	
C02021	Parallel	4510	■	■	■	■		■		■	
		4031	■	■	■	■		■		■	
		4040XP	■	■	■	■		■		■	
		1250	■	■	■	■		■		■	
		1260	■	■	■	■		■		■	
		1450	■	■	■	■		■		■	
		1460	■	■	■	■		■		■	
		4050A	■	■	■	■		■		■	
C02031	Bracket	4110	■	■	■	■		■		■	
		4210	■	■	■	■		■		■	
		4040XP	■	■	■	■		■		■	
		4010	■	■	■	■		■		■	
		4050A	■	■	■	■		■		■	
		4031	■	■	■	■		■		■	
		4040XP	■	■	■	■		■		■	
		1250	■	■	■	■		■		■	
C02041	Top Jamb	1260	■	■	■	■		■		■	
		1450	■	■	■	■		■		■	
		1460	■	■	■	■		■		■	
		4020	■	■	■	■		■		■	
		4050A	■	■	■	■		■		■	
		4031	■	■	■	■		■		■	
		4040XP	■	■	■	■		■		■	
		1250	■	■	■	■		■		■	
C02051	Hinge Side Hold Open	1260	■	■	■	■		■		■	
		1450	■	■	■	■		■		■	
		1460	■	■	■	■		■		■	
		4010	■	■	■	■		■		■	
		4050A	■	■	■	■		■		■	
		4031	■	■	■	■		■		■	
		4040XP	■	■	■	■		■		■	
		1250	■	■	■	■		■		■	
C02061	Parallel Hold Open	1260	■	■	■	■		■		■	
		1450	■	■	■	■		■		■	
		1460	■	■	■	■		■		■	
		4050A	■	■	■	■		■		■	
		4110	■	■	■	■		■		■	
		4210	■	■	■	■		■		■	
		4010	■	■	■	■		■		■	
		4040XP	■	■	■	■		■		■	
C02071	Bracket Hold Open	1250	■	■	■	■		■		■	
		1260	■	■	■	■		■		■	
		1450	■	■	■	■		■		■	
		1460	■	■	■	■		■		■	
		4020	■	■	■	■		■		■	
		4050A	■	■	■	■		■		■	
		4031	■	■	■	■		■		■	
		4040XP	■	■	■	■		■		■	
C02081	Top Jamb Hold Open	1250	■	■	■	■		■		■	
		1260	■	■	■	■		■		■	
		1450	■	■	■	■		■		■	
		1460	■	■	■	■		■		■	
		4020	■	■	■	■		■		■	
		4050A	■	■	■	■		■		■	
		4010	■	■	■	■		■		■	
		4040XP	■	■	■	■		■		■	
C02091	Hinge Side Fusible Link	4010	■	■	■	■		■		■	
		C02101	Parallel Fusible Link	4110	■	■	■	■		■	■
		C02111	Bracket Fusible Link	4010	■	■	■	■		■	■
		C02121	Top Jamb Fusible Link	4020	■	■	■	■		■	■
C02171	Hinge Side Telephone Booth	4010TEL				■					
		4110TEL				■					
C02211	Hinge Side Track	1460T	■	■	■	■				■	
		4010T	■	■	■	■				■	
		4031T	■	■	■	■				■	
		4040XPT	■	■	■	■				■	
		4510T	■	■	■	■				■	

Note: All closers listed in this section are certified grade 1 = 1,500,000 cycles, PT-4A = 15% adjustable closing force, PT-4B = 35% adjustable closing force, PT-4C = 50% adjustable closing force, PT-4D = adjustable hydraulic backcheck, PT-4F = delay action, PT-4G = built-in factory dead stop (Cush-n-Stop), PT-4H = spring power adjustable over a range of sizes, PT-4J = backcheck position advanced 15 degrees.

Surface mounted		ANSI Standard A156.4-2013									
ANSI number	Mounting	LCN closer	PT-4A	PT-4B	PT-4C	PT-4D	PT-4F	PT-4G	PT-4H	PT-4J	
C02221	Hinge Side Hold Open Track	1460T	■	■	■	■				■	
		4010T	■	■	■	■				■	
		4031T	■	■	■	■					■
		4040XPT	■	■	■	■					■
		4031T	■	■	■	■					■
		4040XPT	■	■	■	■					■
		4510T	■	■	■	■					■
C02231	Stop Face Track	1460T	■	■	■	■				■	
		4031T	■	■	■	■				■	
		4040XPT	■	■	■	■					■
		4110T	■	■	■	■					■
C02241	Stop Face Hold Open Track	4210T	■	■	■	■				■	
		1460T	■	■	■	■				■	
		4031T	■	■	■	■					■
		4040XPT	■	■	■	■					■
C02251	Top Jamb Track	4110T	■	■	■	■				■	
		1460T	■	■	■	■				■	
		4000T	■	■	■	■					■
		4020T	■	■	■	■					■
C02261	Top Jamb Hold Open Track	4031T	■	■	■	■				■	
		4040XPT	■	■	■	■					■
		1460T	■	■	■	■					■
		4020T	■	■	■	■					■
C02271	Top Jamb Push Side Flush Frame Track	4031T	■	■	■	■				■	
		4031T	■	■	■	■					■
		4040XPT	■	■	■	■					■
C02281	Top Jamb Push Side Flush Frame Hold Open Track	4031T	■	■	■	■				■	
		1250	■	■	■	■					■
		1260	■	■	■	■					■
C03011	Hinge Side	1450	■	■	■	■				■	
		1250	■	■	■	■					■
		1260	■	■	■	■					■
C03021	Parallel	1450	■	■	■	■				■	
		1250	■	■	■	■					■
		1260	■	■	■	■					■
C03041	Top Jamb	1450	■	■	■	■				■	
		1250	■	■	■	■					■
		1260	■	■	■	■					■
C03051	Hinge Side Hold Open	1450	■	■	■	■				■	
		1250	■	■	■	■					■
		1260	■	■	■	■					■
C03061	Parallel Hold Open	1450	■	■	■	■				■	
		1250	■	■	■	■					■
		1260	■	■	■	■					■
C03081	Top Jamb Hold Open	1450	■	■	■	■				■	
		1250	■	■	■	■					■
		1260	■	■	■	■					■

Note: All closers listed in this section are certified grade 1 = 1,500,000 cycles, PT-4A = 15% adjustable closing force, PT-4B = 35% adjustable closing force, PT-4C = 50% adjustable closing force, PT-4D = adjustable hydraulic backcheck, PT-4F = delay action, PT-4G = built-in factory dead stop (Cush-n-Stop), PT-4H = spring power adjustable over a range of sizes, PT-4J = backcheck position advanced 15 degrees.

Concealed in door		ANSI Standard A156.4-2013			
ANSI number	Mounting	Arm	LCN closer	PT-4A	PT-4D
C04011	Concealed in Door	Regular Arm	3030	■	■
		Hold Open Arm	3030H	■	■
C04031	Concealed in Door	Standard Arm	3130		■
		Hold Open Arm	3130H		■

Note: All closers listed in this section are certified grade 1 = 1,500,000 cycles. PT-4A = 15% adjustable closing force, PT-4D = adjustable hydraulic backcheck.

Overhead concealed

ANSI Standard A156.4-2013

ANSI number	Mounting	Arm	LCN closer	PT-8A	PT-8B	PT-8D	PT-8E	PT-8F	PT-8J	PT-8L
C05011	Butt Hinge	Regular Arm	5010	■	■	■	■	■	■	■
			5030	■	■	■	■	■	■	■
C05021	Pivot	Regular Arm	5010	■	■	■		■	■	■
			5030	■	■	■		■	■	■
C05031	Butt Hinge	Standard Arm	2010	■	■		■	■		■
			2030	■	■		■	■		■
			2210	■		■	■	■		■
			2210 DPS	■		■	■	■		■
			2010	■	■		■	■		■
C05041	Pivot	Standard Arm	2030	■	■		■	■		■
			2210	■		■	■		■	
			2210 DPS	■		■	■		■	
			2010	■	■		■	■		■
C05071	Pivot	Standard Arm	2030	■	■		■	■	■	
C05081	Pivot	Standard Arm	6030	■	■		■	■	■	
C05091	Butt Hinge	Hold Open Arm	5010	■	■	■	■	■	■	■
			5030	■	■	■	■	■	■	■

Note: All closers listed in this section are certified grade 1 = 1,500,000 cycles. PT-8A = door under control from 7 degrees of maximum door opening to close, PT-8B = hold open between 85 and 180 degrees, PT-8D = 50% adjustable PT-8E = single acting, 165 degrees of opening, double acting 165 degrees of opening either way, PT-8F = adjustable hydraulic backcheck, PT-8J = delay action, PT-8L = 35% adjustable closing force.

Life safety closer/holder release device

ANSI Standard A156.15-2001

ANSI number	Mounting	Arm	LCN closer	PT-4D	PT-4N	PT-4P
C00011	Wall	N/A	7830, 7840, 7850			
C00021	Floor	N/A	7820			
C00191	Hinge Side	Standard Arm	4040SE	■	■	■
			4040SEL	■	■	■
C00231	Stop Face	Standard Arm	4040SE	■	■	■
			4040SEL	■	■	■
C00311	Top Jamb	Regular Arm	4410HSA	■	■	
			4410ME	■	■	
C00351	Hinge Side	Standard Arm	4310HSA	■	■	
			4310ME	■	■	
C00371	Hinge Side	Swing Free Arm	4310ME	■	■	
C00391	Top Jamb	Double Egress Arm	4310HSA	■	■	
			4310ME	■	■	
C00471	Hinge Side	Regular Arm	4040SEH			■
C00511	Push Side	Regular Arm	4040SEH			■
C00611	Concealed	Standard Arm	3130SE	■		■
			3130SEL	■		■
C00651	Concealed	Standard Arm	2310ME	■	■	

Note: Options are; PT-4D = adjustable hydraulic backcheck, PT-4N = adjustable spring power, and PT-4P = adjustable hold open intensity.



## Abbreviations

## Arm options

<b>CUSH</b>	Cush-n-Stop Arm
<b>DE</b>	Double Egress Arm
<b>DHWP</b>	H Arm with 62PA for Delay
<b>DRWPA</b>	Regular Arm with 62PA for Delay
<b>EDA</b>	Extra Duty Arm
<b>EDAW62G</b>	Extra Duty Arm with 62G Thick Hub Shoe
<b>FL</b>	Fusible Link Arm
<b>H</b>	Hold Open Arm
<b>HCUSH</b>	Hold Open Cush-n-Stop Arm
<b>HEDA</b>	Hold Open Extra Duty Arm
<b>HEDA62G</b>	Hold Open Extra Duty Arm with 62G Thick Hub Shoe
<b>HLONG</b>	Hold Open Long Arm
<b>HWPA</b>	Hold Open with Parallel Arm Bracket
<b>LONG</b>	Long Arm
<b>REGARM</b>	Regular Arm (Non-handed)
<b>RWPA</b>	Regular Arm with Parallel Arm Bracket
<b>RW62A</b>	Regular Arm with 62A Auxiliary Shoe
<b>SCUSH</b>	Spring Cush-n-Stop Arm
<b>SF</b>	Swing Free Arm
<b>SHCUSH</b>	Spring Hold Open Cush-n-Stop Arm
<b>STDTRKARM</b>	Standard Arm (Handed)
<b>STDTRKSECARM</b>	Standard Security Arm (Handed)
<b>XLONG</b>	Extra Long Arm

## Control box options

<b>CTRL</b>	Standard Controller
-------------	---------------------

## Cylinder options

<b>CYL</b>	Cast iron or aluminum cylinder assembly
<b>CYL18G</b>	Standard Cylinder with 18G mounting plate
<b>CYL80G</b>	Bypass Hold Open up to 80 Degrees with 18G mounting plate
<b>CYL140G</b>	Bypass Hold Open up to 140 Degrees with 18G mounting plate
<b>CYLAVB</b>	Advanced Variable Backcheck
<b>CYLB80</b>	Bypass Hold Open up to 80 Degrees
<b>CYLB140</b>	Bypass Hold Open up to 140 Degrees
<b>CYLDEL</b>	Delay Action Cylinder
<b>CYLTEL</b>	Telephone Booth Cylinder

## Cover options

<b>CL</b>	Cover Length
<b>DS</b>	Designer Series Metal Cover
<b>FC36</b>	Full 36" Cover
<b>FPC</b>	Full Plastic Cover
<b>LESSCOV</b>	Less Cover
<b>MC</b>	Metal Cover
<b>MC27</b>	Standard 27" Metal Cover
<b>MC72</b>	Standard 72" Metal Cover
<b>PC</b>	Plastic Cover
<b>SLIMPC</b>	Slim Line Plastic Cover

## Track options

<b>BUMP</b>	Track with Bumper
<b>H</b>	Hold Open Track
<b>HBMP</b>	Hold Open Track with Bumper
<b>LESSTRK</b>	Less Track
<b>LONG</b>	Long Track
<b>STDSECTRK</b>	Standard Security Track (non-handed)
<b>STDTRK</b>	Standard Track (Non-handed)

## Fastener pack options

<b>LESSCPK</b>	Less Screws
<b>MS</b>	Machine Screws
<b>MTBMS</b>	Metric Metal Through Bolt Machine Screws
<b>MWMS</b>	Metric Metal and Wood Machine Screws
<b>SRT</b>	Self Reaming and Tapping Screws
<b>TBSRT</b>	Through Bolt Self Reaming and Tapping Screws
<b>TBTRX</b>	Through Bolt and Torx Machine Screws
<b>TBWS</b>	Through Bolt Wood and Machine Screws
<b>TORX</b>	Torx Machine Screws
<b>UNIV</b>	Universal Screws
<b>WMS</b>	Wood and Machine Screws

## Motor gearbox options

<b>MGB</b>	Standard Motor Gearbox
------------	------------------------

## Powder coat finishes

<b>622</b>	Matte Black Paint
<b>689</b>	Aluminum Paint
<b>690</b>	Statuary Bronze Paint
<b>691</b>	Light Bronze Paint
<b>693</b>	Gloss Black Paint
<b>695</b>	Dark Bronze Paint
<b>696</b>	Brass Paint

## Miscellaneous terms

<b>BKY</b>	Breakaway Stop
<b>DPS</b>	Door Position Switch
<b>ELR</b>	Extra Long Rod
<b>ES</b>	Electric Strike Relay (control boxes)
<b>FCA</b>	Flush Ceiling Application
<b>HDR2</b>	Double Door Header
<b>HL</b>	Header Length
<b>HSA</b>	Hold Open/Scanner Activated
<b>LH</b>	Left Hand
<b>LR</b>	Long Rod
<b>ME</b>	Multi Point Hold Open Series
<b>PA</b>	Parallel Arm
<b>PAH</b>	Parallel Arm Holder
<b>POS</b>	Positive Stop
<b>RF</b>	Radio Frequency
<b>RH</b>	Right Hand
<b>S</b>	Sequential (control boxes)
<b>SE</b>	Single Point Hold Open Series
<b>SRI</b>	Special Rust Inhibitor
<b>ST</b>	Special template
<b>T</b>	Track
<b>TJ</b>	Top Jamb
<b>XP</b>	Extra Protection

# Terms

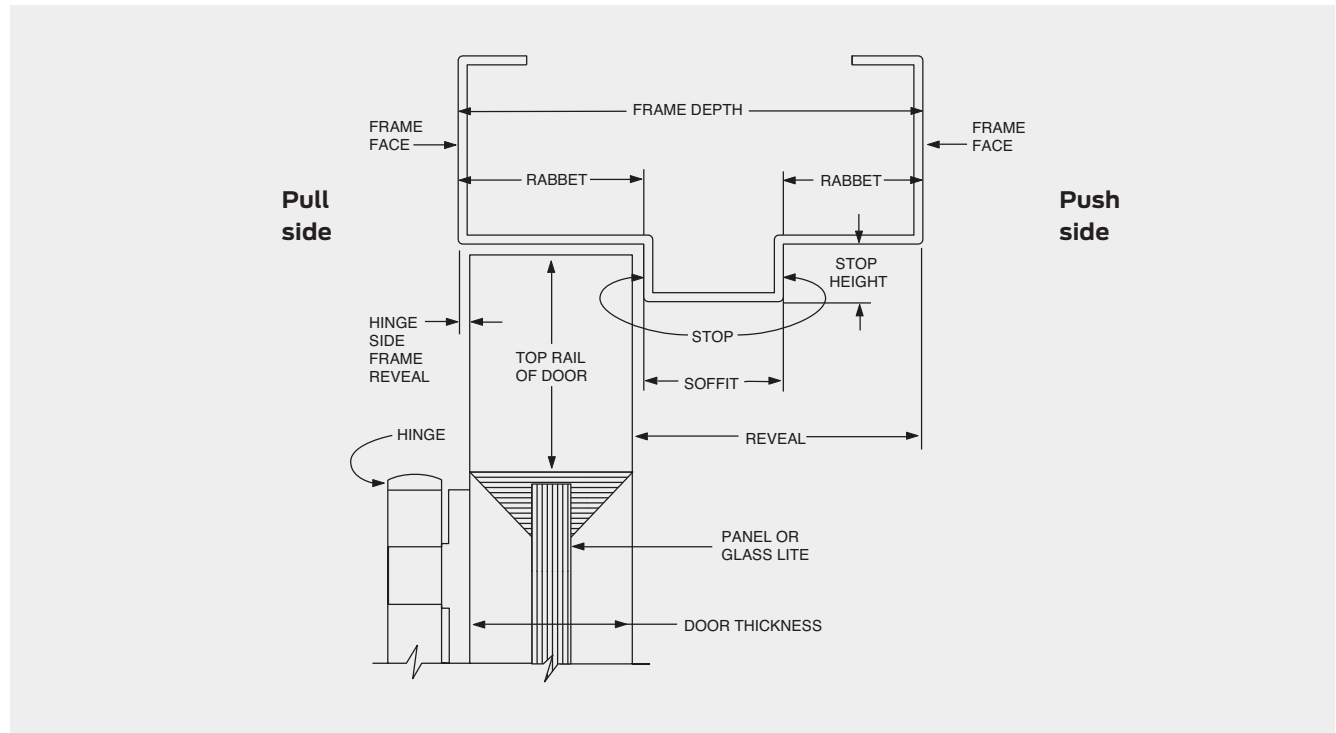

## A

**ADA** – Americans with Disabilities Act.

**Advanced Variable Backcheck (CYLAVB)** – Optional cylinder that starts backcheck at about 45° (2A) instead of the normal 75° (2).

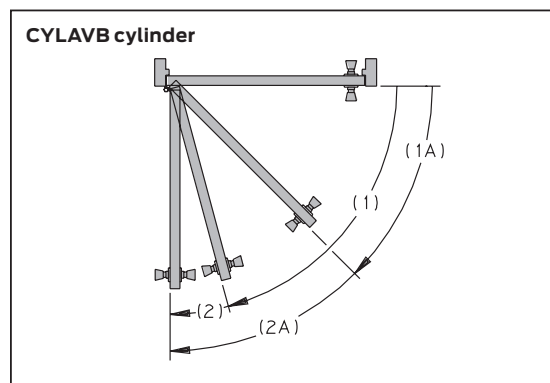

**Anodized** – An electrochemical process that thickens and toughens the protective oxide on aluminum metal.

**ANSI** – American National Standards Institute publishes standards for commercial hardware. A156.4 is the basic door closer standard.

**Applied stop** – Surface mounted stop attached to a cased opening frame.

**Arch top door** – Any door with an arched top rail.

**Armature extension** – Standard metal extensions available for SEM magnets where the armature does not reach the magnet. Available in 1/2", 3/4", 1", 2", 4" or a kit including all sizes.

**Autoequalizer™** – An LCN specific term for an electric or a pneumatic automatic operator. System is low-energy and carries a two-year warranty.

**Automatic operator** – A term used to describe a type of automated opening system.

**Auxiliary door stop** – Hardware designed and installed to limit the swing of a door.

## B

**Backcheck** – Hydraulic circuit designed to cushion the doors opening swing at about 75°. Standard on all LCN closers.

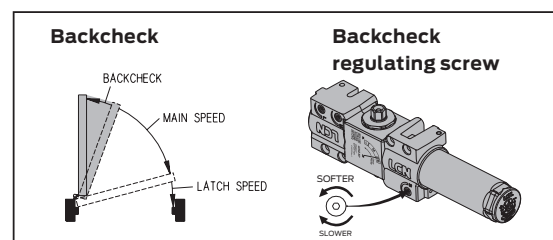

## Terms

**Backcheck selector valve** – Valve used to provide proper backcheck location for 4040XP and 4050A parallel arm mounting.

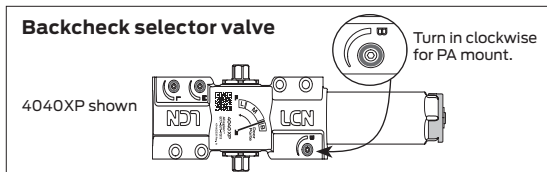

**Blade stop** – Narrow frame stop that will not accept a parallel arm shoe.

**Blade stop spacer** – Spacer lowers a parallel arm 1/2" so the arm will clear a blade stop.

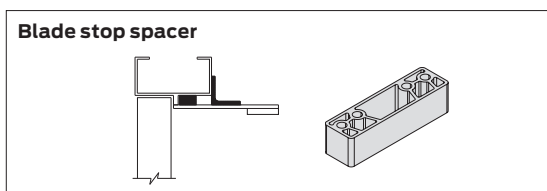

**Blow-open** – A type of control box that is used for a smoke evacuation system. Can be used with or without a normal automatic operator system.

**Breakaway stop (BKY)** – An optional safety device that permits egress on in-swinging exterior doors by allowing them to swing out in case of an emergency. Used with overhead concealed, center pivoted in-swinging doors.

**Brite Metallic (MTLPC)** – Custom powder coat finish, which resembles that of 651 or 652 plated finish.

**Bypass cylinder** – ME cylinder that will not hold open within a specified range of door swing.

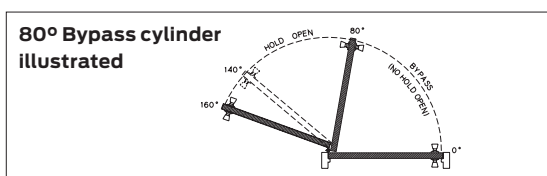

## C

**Cased opening** – Frame section without stops.

**Cast aluminum** – Material used in producing LCN's competitively priced door closers.

**Cast iron** – Material used in producing high quality door closers.

**Clearance** – Distance from a PA shoe to the push side of door or distance from the pull side of door to the wall on 90° installations.

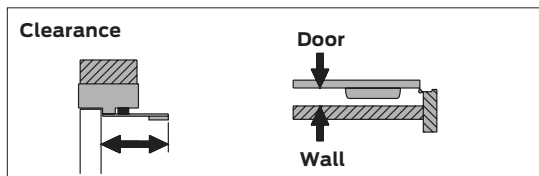

**Closing force** – Energy generated by a closer to close and latch the door.

**Control box, standard, 9100 Series** – Microprocessor door control without Power Boost or built in power supply.

**Control box, 2800, 9500 Series** – Microprocessor door control, includes adjustment for opening, closing and backcheck speeds. Features Push 'N Go and Power Boost.

**Control box, 7900 Series** – Heavy duty, surface mounted control box that contains one or two electrically controlled pneumatic circuits.

**Controller assembly** – Digital control suite used in the LCN automatic operator. Includes adjustments for opening force and opening speed.

**Concealed in door** – Closer with cylinder concealed in the top rail of the door with either an exposed or concealed arm.

**CUSH shoe support** – Support provides fifth screw anchorage of CUSH shoes on frames with narrow push side reveals.

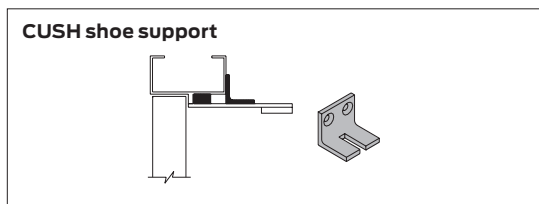

**Cush-n-Stop arms (CUSH)** – Extra duty, parallel arm that includes a stop in the CUSH shoe.

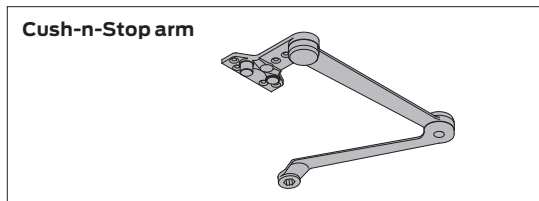

**Custom Powder Coat (RAL)** – An optional powder coat finish. Currently, LCN offers a wide selection for special powder coat finishes. LCN uses a European color standard, referred to as an RAL #, to differentiate between finishes.

## Terms

**Cutout** – Preparation of the top rail of a door or frame for concealment of the closer, arm or track.

**Cylinder assembly (CYL)** – Main closer component complete with any mounting plates or electronics.

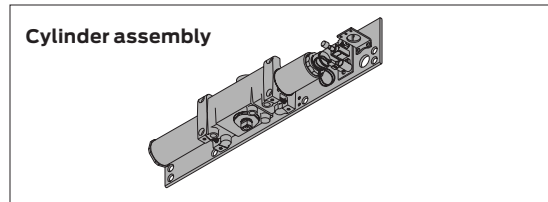

**Cylinder only** – Hydraulic cast iron cylinder.

## D

**Deep reveal** – Reveal deeper than what an arm will accommodate.

**Delay Action Cylinder (CYLDEL)** – Delays closing from maximum opening to approximately 75°.

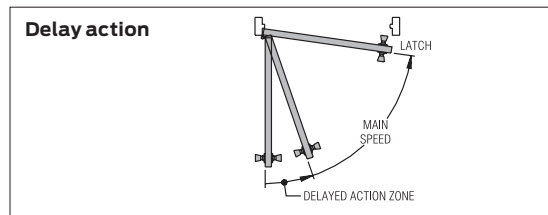

**Designer Series Metal Cover (DS)** – An aesthetically pleasing cover design that appeals to many types of facilities and architects.

**Door Position Switch (DPS)** – A security option specific to the 2210 Series closer. A door position switch is used to monitor the closed position of a door in an opening.

**Double Door Header (HDR2)** – One electromechanical automatic operator and one manual door within the same header, for a pair of doors.

**Double acting** – Term used to describe door swing. A double acting frame does not have a stop thus allowing the door to swing 95° in both directions.

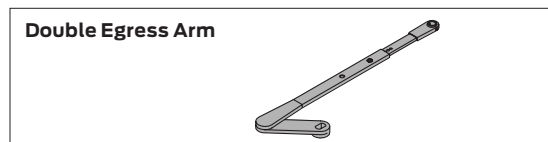

**Double lever arm** – Two-part arm hinged at the elbow that provides superior leverage. Used on hinge side, top jamb and parallel arm mountings, the geometry of the arm provides greater mechanical advantage to the closer.

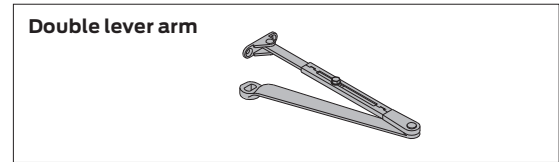

**Double rabbet frame** – Frame with a recess or offset formed on both sides of a stop to receive a door.

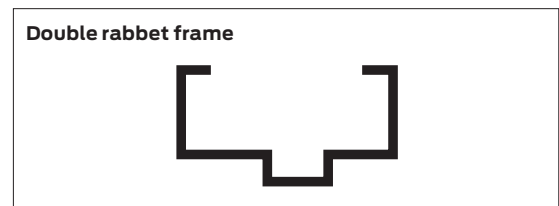

**Drop plate** – Designed to mount a closer on top rail or head frame to meet special conditions or mounting surface dimensions that are below minimums.

## E

**Electric strike** – An optional, electronic latching device that replaces a regular lock strike in a doorframe that allows the door to open from a remote location or by special access equipment.

**Electric strike relay (ES)** – An optional feature found in an LCN 7900 Series control box that can be used to control an electric strike.

**Electrohydraulic automatic operator** – Automatic operator with an electrically controlled opening feature and hydraulic closing feature.

**Electromechanical automatic operator** – Automatic operator with an electrically controlled opening feature and closing feature.

**Escutcheon** – An optional, protective or decorative plate that can be installed with many surface mounted actuators.

## Glossary

## Terms

**Extra Duty Arm (EDA)** – Double lever arm with both main and forearm made of solid forged steel for extra strength.

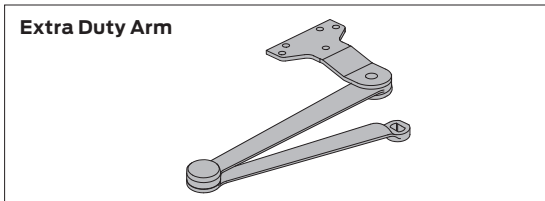

**Extra Long Arm (XLONG)** – 4040XP Series double lever arm for exceptionally deep reveals or other special applications.

## F

**Fifth screw** – Mounting screw farthest from the door on a parallel arm shoe.

**Fifth screw spacer** – Supports PA shoe mounted on frame stop.

**Finish plate** – Decorative plate applied to overhead concealed closer to conceal closer mounting plate and screws.

**Fire shield** – 22-gauge steel liner mounts in the track mortise of the door's top rail for 20 minute labeled wood doors.

**Flush Ceiling Application (FCA)** – Condition when the ceiling is at the same height as the top of the frame.

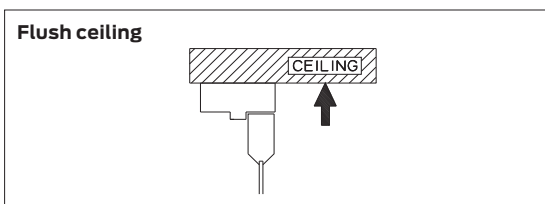

**Flush panel adapter** – Adapter provides PA shoe mounting surface when door and frame are flush.

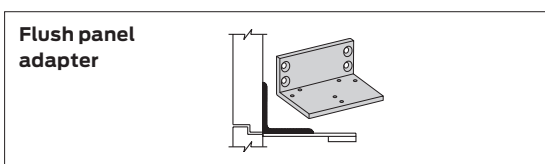

**Forearm** – Arm part that connects main arm to the shoe attachments in a double lever arm system.

**Frame depth** – Face to face dimension of the frame.

**Frame face** – Exposed part of frame parallel to face of the wall.

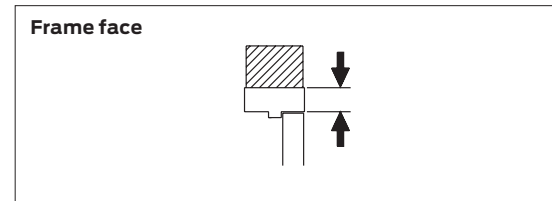

**Full complement bearings** – Low friction, high load needle bearings found in all LCN closers.

**Full Plastic Cover (FPC)** – Cover that encloses cylinder assembly except for shaft/arm attachment.

**Fusible Link Arm (FL)** – Releases hold open function when exposed to high temperatures. 135°F and 165°F available.

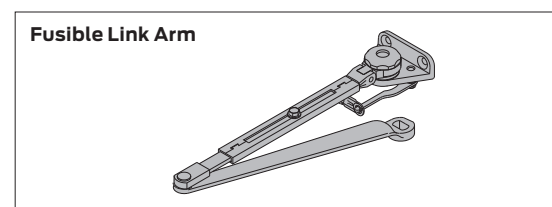

## G

**(LCN®) Green Dial** – The LCN Green Dial is located on the end of the spring tube on selected heavy duty closers. Designed to help installers accurately adjust the closer power to match the conditions of the entrance.

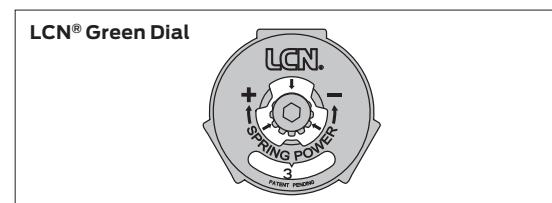

## H

**Hand** – Direction of a door's swing, either right or left.

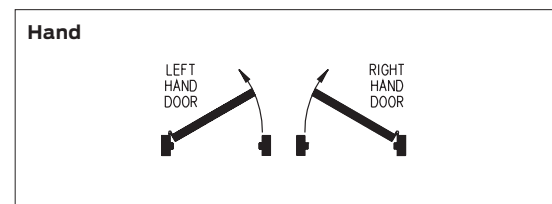

**Handed** – Closer or part designed for ONLY right or left swinging doors.

**Head frame** – Member of the frame above the door.

## Terms

**Header** – Aluminum enclosure for motor gearbox and controller.

**Hinge side** – Face of door and frame on which the hinge pivot point is located.

**Hinge side mount** – Mounting with the closer cylinder on the hinge side of the door top rail.

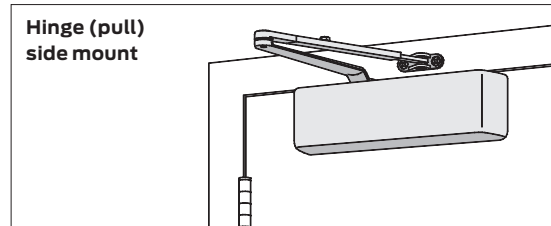

**Hinge side reveal** – Depth measured from the frame face to the pull side of the door face.

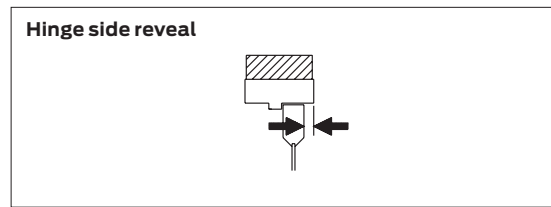

**Hinge stile** – Vertical member of a door prepared for installation of hinges.

**Hold Open Arm (H)** – Double lever arm that provides hold open function that is either adjustable at elbow or shoe.

**Hold open clip** – Located in track to provide hold open function for single lever arms.

**Hold Open Cush-n-Stop Arm (HCUSH)** – Parallel arm that features solid forged steel main arm and forearm with stop in soffit shoe. Uses control handle to select hold open function.

**Hold Open Long Arm (HLONG)** – Hold open arm extended by a long head and tube for deep reveals.

**Hold Open Track with Bumper (HBMP)** – Track with hold open clip and bumper assembly installed.

**Hold Open/Scanner Activated (HSA)** – Electrically controlled closer/holder with built-in scanner.

**Hydraulic fluid** – Fluid metered by valve system to control door.

**Independent pair** – Two automatic doors that function separately.

## J

**Jamb** – The vertical member that forms the sides of a door frame. There is a hinge side jamb and a strike side jamb.

## L

**Labeled door** – Conforms to all applicable codes, requirements, and procedures governing fire rated doors and bears the manufacturer's identification label.

**Latch speed** – Separate adjustment to control the last few degrees of the door's closing swing.

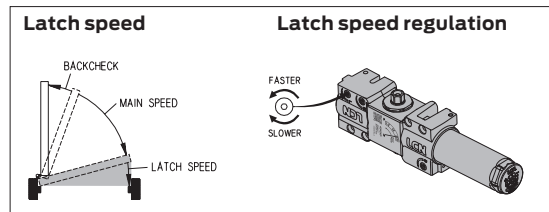

**Lock stile** – Vertical member of a door prepared for installation of a lock.

**Long Arm (LONG)** – Extended arm for deep reveals or other special applications.

**Low energy operator** – A type of automated opener used on a door that should take approximately 5 seconds to open to 90°. Low Energy operators do not require safety devices or guide rails. Conforms to ANSI A156.19.

## M

**Main arm** – Connects to the cylinder in a double lever arm system.

**Main speed** – Separate adjustment to control closing swing of the door to within a few degrees of latch.

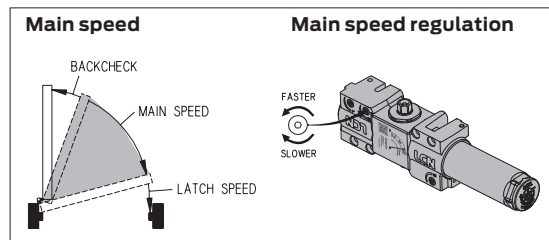

**Maximum opening** – Furthest degree of door opening.

**Metal Cover (MC)** – Stamped metal cover required for optional plated finishes and custom powder coat finishes. Standard cover with High Security Series closers.

## Glossary

### Terms

**Motor clutch** – The geared assembly in an LCN electric automatic operator. Once activated, the motor clutch drives the door open.

**Mortise** – Material removed from frame and/or top rail of door.

**Mounting/finish plate** – Plate with exposed mounting screws and finish applied.

**Multi Point Hold Open Series (ME)** – Infinite hold open points from 0° up to maximum opening.

## N

**No destruct feature** – A feature specific to the motor clutch assembly portion of an LCN electric automatic operator. This feature does not allow the user to back drive the motor, which could cause damage to the unit.

**Non-handed** – Closer or part designed for both right and left hand swinging doors.

**Non-sized** – Cylinder assembly with spring power adjustable over a range of sizes.

## O

**Opening force** – Force required to open the door against the closers spring power.

**Overhead concealed** – Closer with cylinder concealed in head frame and either a concealed or exposed arm.

## P

**PA shoe adapter** – Adapter provides horizontal mounting for PA shoe on a flush door and frame.

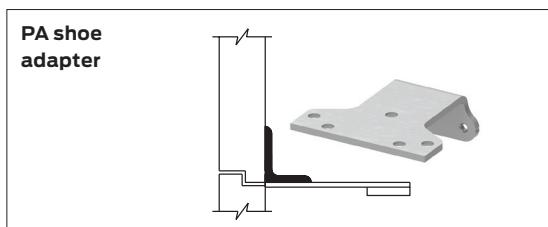

**PA shoe** – Attaches the forearm to the soffit for a parallel arm system.

**Packing nut** – A threaded part that holds the pinion in place. Usually, the LCN model number and date of manufacture are stamped into this part. The date of manufacture is important because the owner can determine if the cylinder is in or out of warranty.

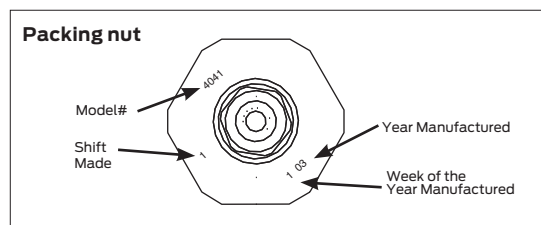

**Parallel arm** – A push side mounted double lever arm system where main arm is parallel to the door when in the closed position.

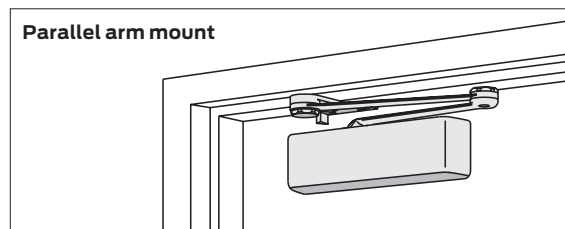

**Parallel Arm Holder (PAH)** – An item usually used on the inactive leaf of a pair of doors for hold open where the active leaf has a closer installed.

**Pinion** – Transfers rotary motion of the arm system to the piston. Also provides attachment of arms to closer.

**Piston** – One of the internal pieces of a door closer. The piston is moved by the rotating pinion, which in turn compresses the spring.

**Positive Stop (POS)** – Door stop for overhead concealed, center pivoted out swinging doors.

**Pneumatic** – This type of LCN Automatic Operator is driven by an air source. The air source can be built into the control box or provided separately within the building.

**Power boost** – Provides additional closing force to ensure latching.

**Powder coat** – A standard finishing process that provides a very durable, corrosion resistant covering to the majority of products that LCN offers. An LCN powder coat finish offers over four times the ANSI salt spray test of 25 hours.

# Terms

**Pull side** – Hinge side of door.

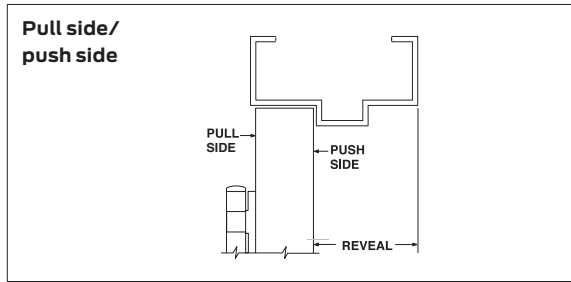

**Push side** – Face of door on stop side of frame.

**Push 'N Go** – Provides power opening after partial (5°) manual opening of door.

## Q

**Quick fix plate™** – Retrofit mounting plate for the LCN 1260 closer used for closer replacement in push/pull applications.

## R

**Rabbet** – Recess or offset formed in the face to receive a door.

**Radio frequency (RF)** – A method of actuating LCN Automatic Operators. A RF transmitter signals a RF receiver to open a door.

**Regular Arm (REGARM)** – A double lever, non hold open arm.

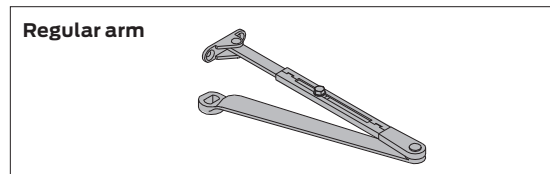

**Regulating screw** – Valve that adjusts flow of hydraulic fluid within cylinder to control door closing speed.

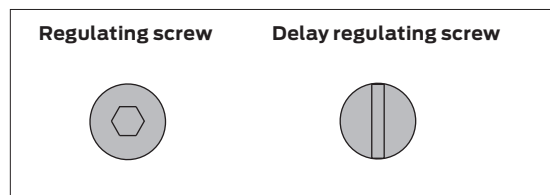

**Reveal** – Depth measured from the frame face to the door face.

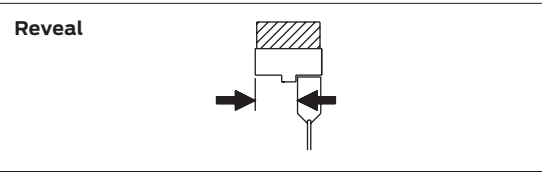

**Rod and shoe** – Part of forearm that provides adjustable length feature for double lever arms.

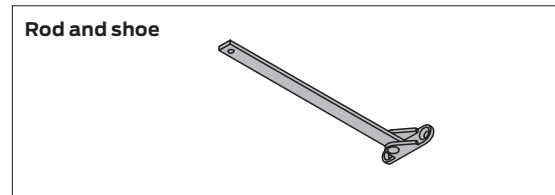

## S

**Self Reaming and Tapping Screw (SRT)** – Phillips head screw with self-reaming and self-tapping capability used in mounting installations.

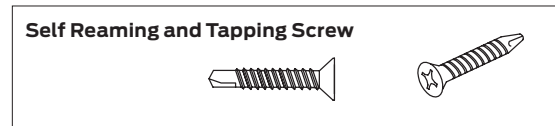

**Second chance feature** – A feature that allows the Automatic Operator two attempts at opening the door. If resistance is encountered on the first attempt, the operator will pause and then try a second time. This feature is standard on the LCN electric automatic operators.

**SEM** – SEM is short for 'single-point electronic magnet'. An actual product number is required when ordering.

**Sentronic** – A general term for the fire/life safety products that are offered by LCN.

**Sequence** – An option to the LCN series of automatic operators. This option allows a pair of vestibule doors to open one after the other.

**Shoe** – Attaches forearm to frame or door face in a double lever arm system.

**Simultaneous pair** – Two automatic doors that open at the same time.

**Single Point Hold Open Series (SE)** – Electrically controlled hold open using a special track and single lever arm.



## Terms

**Single rabbet frame** – Frame with a recess or offset formed on one side of a stop to receive a door.

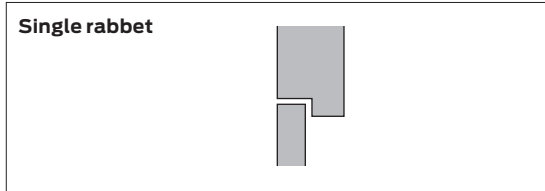

**Sized** – A closer with a specific closer power for proper door applications.

**Slider** – This part is used in conjunction with a track roller in a Sentronic track assembly.

**Slim Line Plastic Cover (SLIMPC)** – A cover that conceals the cylinder but exposes both pinion shafts.

**Soffit** – Horizontal surface of a frame between vertical stops on a double rabbet frame.

**Soffit shoe** – Connects parallel arm shoe to soffit.

**Special Rust Inhibitor (SRI)** – A special corrosion resistant pre-treatment that is available for most LCN closers. Adding SRI to the standard LCN powder coat finish gives the closer a tremendous advantage over a potentially corrosive environment.

**Special Template (ST)** – A special template is usually a modification to a standard product. Either the product itself changes location in the opening or a component is modified from the standard offering to accommodate other hardware or door and frame dimensions.

**Spring Cush-n-Stop Arm (SCUSH)** – Non-handed parallel arm for abusive applications. Features solid forged steel main arm and forearm with spring loaded stop in the soffit shoe.

**Spring Hold Open Cush-n-Stop Arm (SHCUSH)** – Non-handed parallel arm for abusive applications features solid forged steel main arm and forearm with spring loaded stop in the soffit shoe. Uses control handle to select hold open function.

**Spring power** – Closing force exerted by the spring inside the cylinder to close the door.

**Spring power adjustment** – Mechanical pre-loading of spring to adjust closing force.

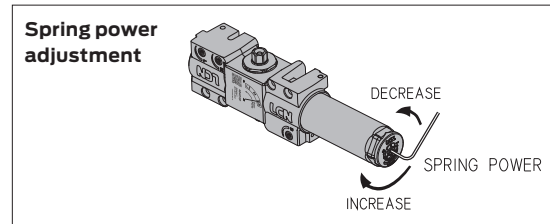

**Spring tube** – Part of the closer assembly that contains the spring.

**Standard cylinder** – Cylinder with main speed, latch speed, and backcheck adjustments.

**Standard Motor Gearbox (MGB)** – Electromechanical drive unit.

**Standard Track Arm (non-handed) (STDTRKARM)** – Directly connects cylinder and track/roller assembly on the door or frame.

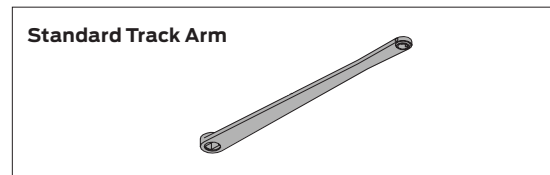

**Standard Track** – Non Hold Open Track.

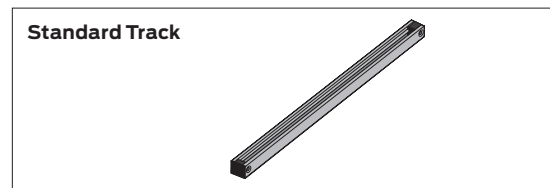

**Stop** – Part of frame against which the door closes.

**Stop height** – Distance the stop extends below the frame face.

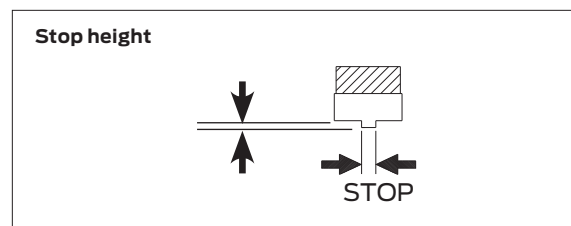

## Terms

**Swing Free Arm (SF)** – ME arm designed to allow free movement of the door without disengaging the holding mechanism.

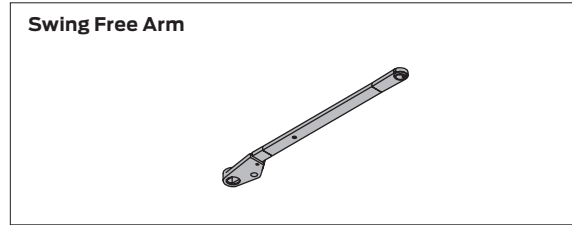

**Track bumper** – Mounts in track to cushion opening swing, but reduces maximum opening. This is not a substitute for a mechanical door stop.

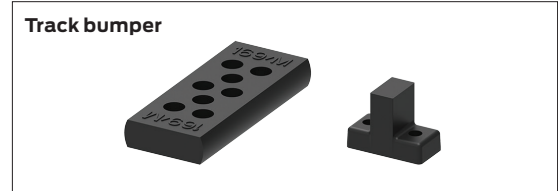

## T

**TBSRT** – Through Bolt Self Reaming and Tapping Screws.

**TBTRX** – Through Bolt and Torx Machine Screws.

**TBWMS** – Through Bolt Wood and Machine Screws.

**Thick hub shoe (62G)** – Substituted for soffit shoe on EDA arm to clear blade stop.

**Top Jamb (TJ)** – Mounting with closer installed on frame face.

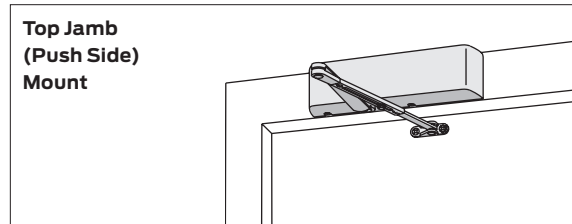

**Transformer** – Electrical device to reduce voltage from 120V AC to 24V AC.

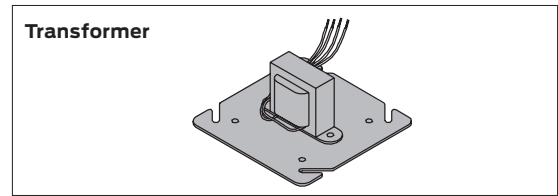

**Tri-voltage** – SEM magnets available with current inputs of 12v, 24v and 120v.

## U

**Ultra liquid X** – All weather fluid that does not change viscosity over a wide temperature range.

**Universal** – A term used to describe a door closer. Closers of this nature are non-sized and non-handed.

**Top rail** – Horizontal top member of a door that connects the latch and hinge stiles. Height is measured from stop on push side.

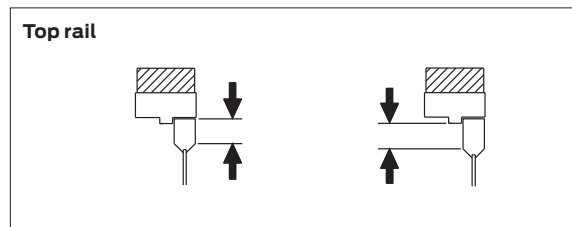

## V

**Vestibule** – A small lobby or entrance that has at least two doors. One door is to the exterior and the other to the interior of the building. A variation could be multiple doors or banks of doors.

## W

**WMS** – Wood and Machine Screws.

**Wood mounting clip** – Designed to ease installation of concealed closer in wood frame.

**Torx** – Security machine screw with Torx drive and security pin for tamper resistant applications.

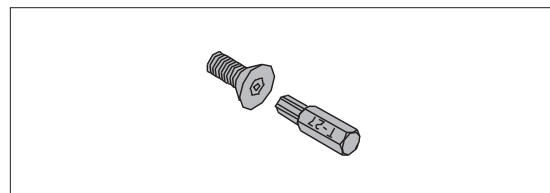

## Warranty

### Limited warranty

Subject to the terms and conditions of this limited warranty, Schlage Lock Company, LLC (the “Company”) extends a limited warranty against defects in material and workmanship for its LCN branded product(s) identified in the Product Table below (“Products”) as installed in the original location.

This limited warranty applies to Products purchased on or after March 3, 2014.

#### Product table - cast iron

4000 Series	30 Years
1460 Series	30 Years
1260 Series	20 Years
Concealed, High Security (except 2210DPS)	15 Years
Automatic Operators; SE, ME, HSA, SEH Series; SEM Magnets; 2210 DPS (includes both electronic and mechanical components)	2 Years

#### Product table - cast aluminum

1250 Series	15 Years
1450 Series	25 Years
4050A Series	25 Years

**Term:** The limited warranty period for products is as stated in the product table above. The “Commencement Date” for a limited warranty period shall be the date of Company’s delivery to the original purchaser of the Products. Proof of Product purchase may be required by Company to confirm the Commencement Date.

**What Company will do:** Company may require proof of Product purchase in order to provide coverage under this limited warranty. As Company’s only responsibility and user’s only remedy under this limited warranty, Company will furnish a replacement Product upon receipt and confirmation by Company, in its sole opinion, that the Product has, in fact, failed due to a manufacturing defect under normal use and maintenance. In the event a replacement Product cannot be provided, Company will either provide a suitable replacement Product or a refund in the amount of the original purchase price.

**What is not covered:** The following costs, expenses, and damages are not covered by the provisions of this limited warranty: (i) labor costs including, but not limited to, such costs as removal and installation of Product; (ii) shipping and freight expenses required to return Product to Company; (iii) failures, defects, or damage caused by any third party product or service; (iv) any other incidental, consequential, indirect, special and/or punitive damages, whether based on contract, warranty, tort (including, but not limited to, strict liability or negligence), patent infringement, or otherwise, even if advised of the possibility of such damages.

**The provisions of this limited warranty do not apply to product that is:** (i) not the proper size for the application for which the Product is used; (ii) not installed in accordance with Company’s published Product installation instructions; (iii) installed with improper parts and/or incorrect parts (NOTE: It is recommended that Product be installed with LCN fasteners provided with Product); (iv) improperly stored, maintained, or operated; (v) modified, repaired, or altered in Company’s sole opinion, in any manner, without the express written consent of Company; (vi) used for purposes for which the Product is not designed or intended; (vii) subjected to misuse, abuse, negligence, or accident; or (viii) subjected to improper temperature, humidity, or other environmental conditions.

Note: 900/7900 Series compressors are not manufactured by Company and are excluded from coverage under this limited warranty. For more information, parts, or repairs concerning the compressors, contact the compressor manufacturer directly at (269) 926-6171.

**Additional terms:** This limited warranty is in lieu of all other warranties, express or implied. Company does not authorize any person to create for it any obligation or liability in connection with Product. Company’s maximum liability hereunder is limited to the original purchase price of the Product. No action arising out any claimed breach of this limited warranty by Company may be brought by the user more than one (1) year after the cause of action has arisen.

**How local law applies:** This limited warranty gives you specific legal rights, and you may also have other rights as permitted by law. Some local laws do not allow limitations on how long an implied warranty lasts or the exclusions or limitation of incidental or consequential damages so the limitations or exclusions provided herein may not apply to you.

**Program and warranty claims:** If product is to be claimed to be defective under this limited warranty, contact Customer Care at (877) 671-7011.

Note: Please contact LCN Customer Care prior to returning any product back to the factory. You will need prior authorization and an RMA for your return.

## About Allegion

Allegion (NYSE: ALLE) is a global pioneer in seamless access, with leading brands like CISA®, Interflex®, LCN®, Schlage®, SimonsVoss® and Von Duprin®. Focusing on security around the door and adjacent areas, Allegion secures people and assets with a range of solutions for homes, businesses, schools and institutions.

For more, visit [www.allegion.com](http://www.allegion.com)

KRYPTONITE ■ LCN ■  ■ STEELCRAFT ■ VON DUPRIN